

①

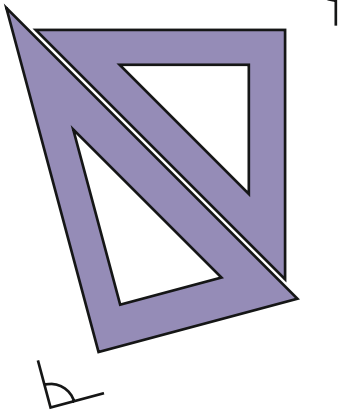

⑤

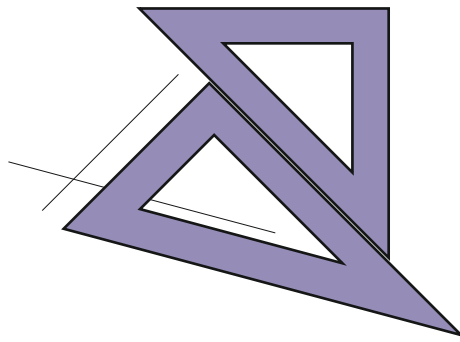

②

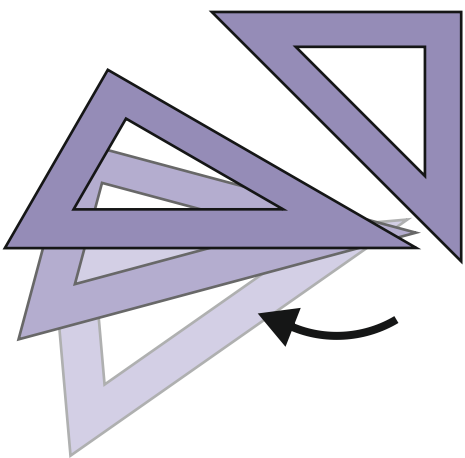

⑥

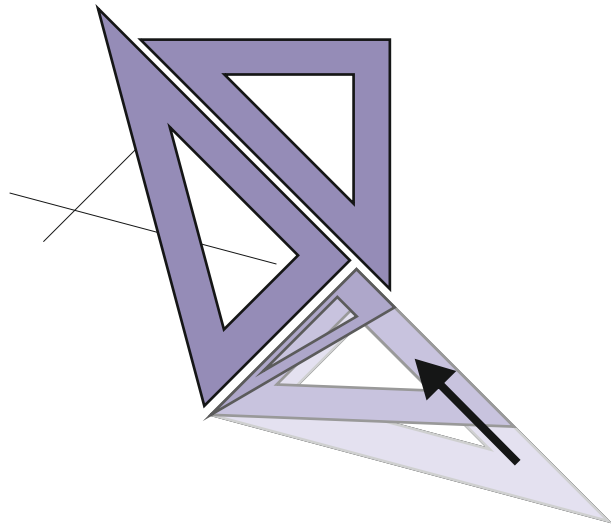

③

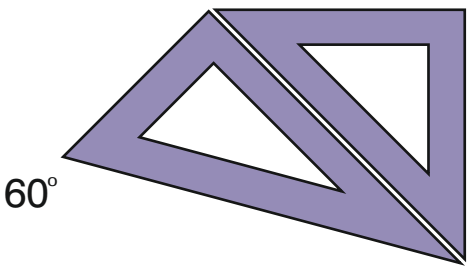

⑦

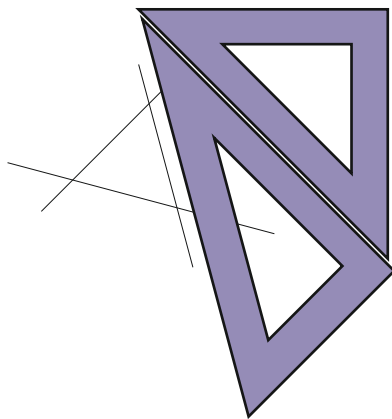

④

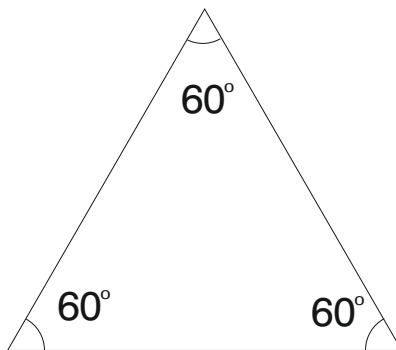
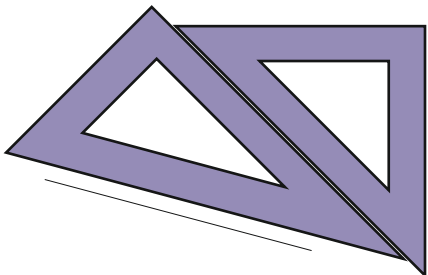

Zurdos

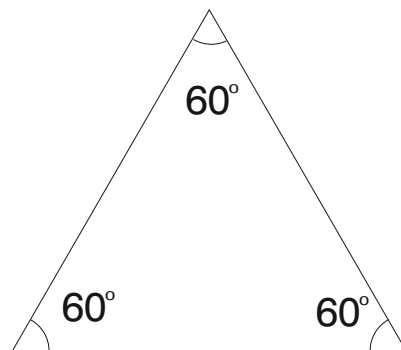
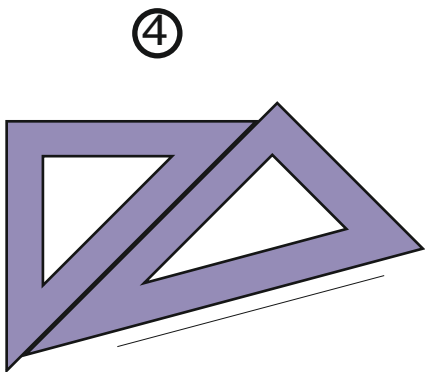
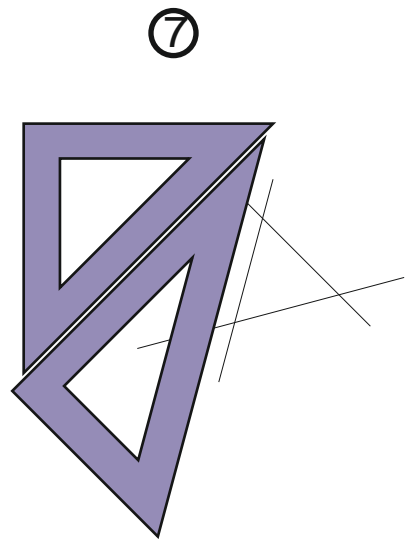
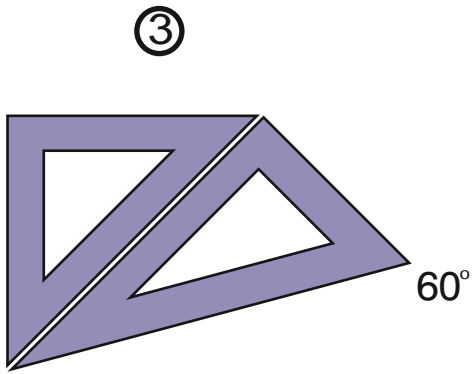
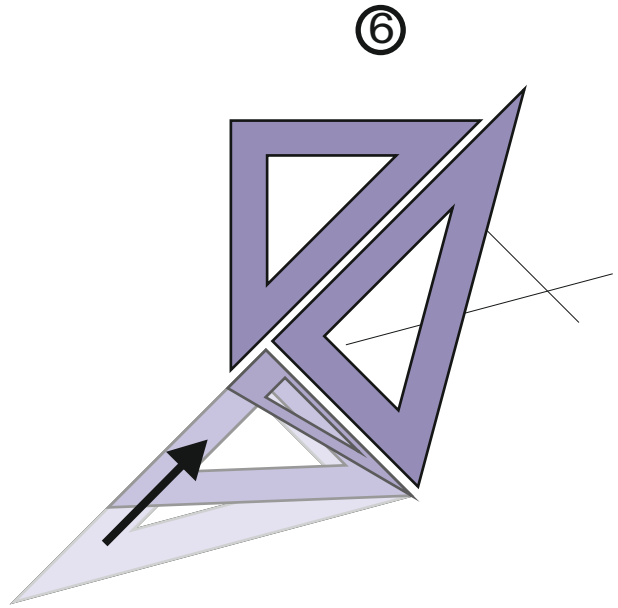
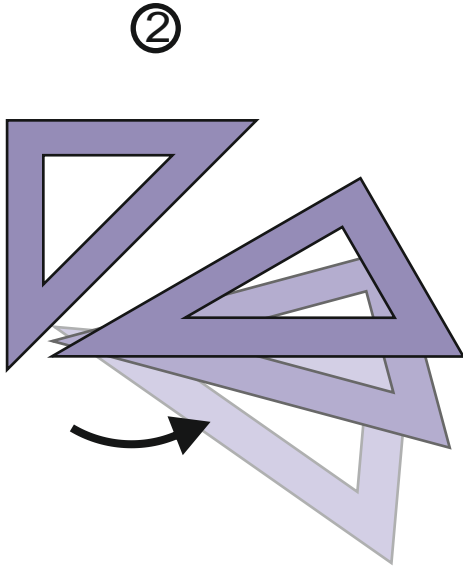
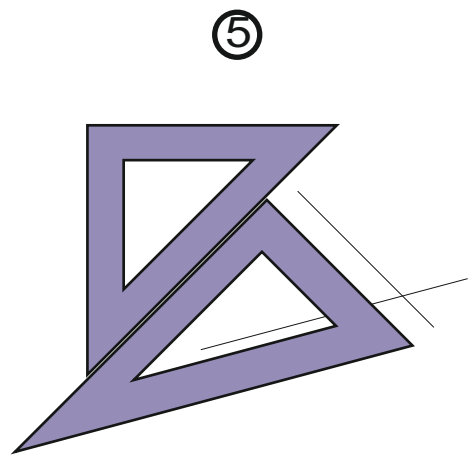
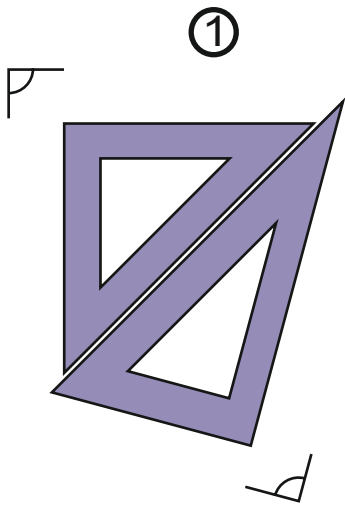

Diestros

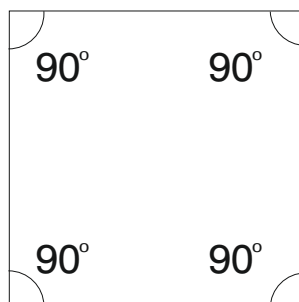
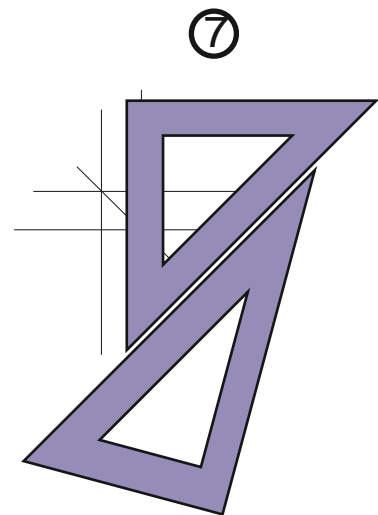
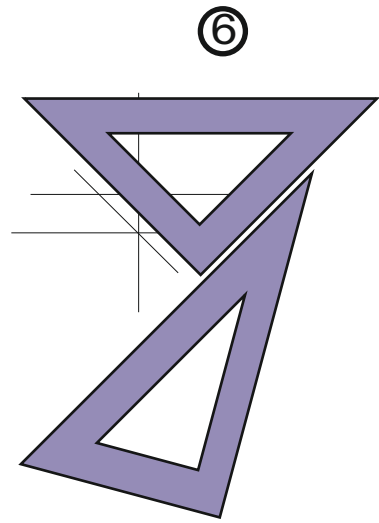
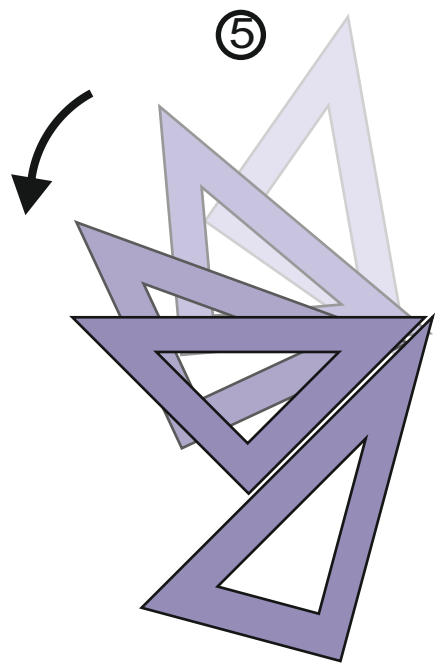
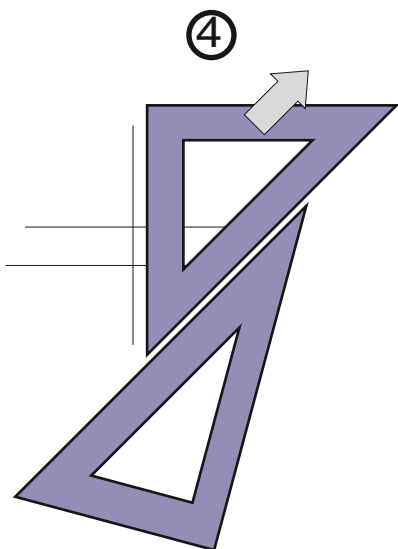
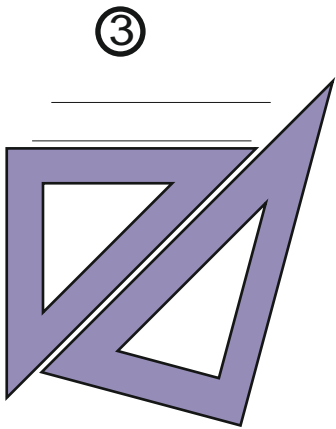
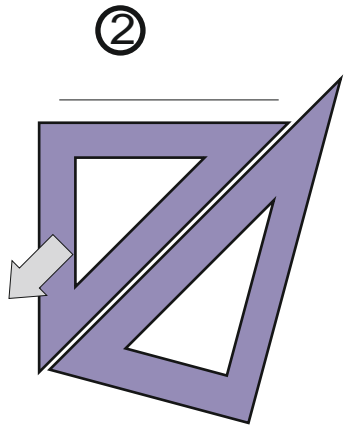
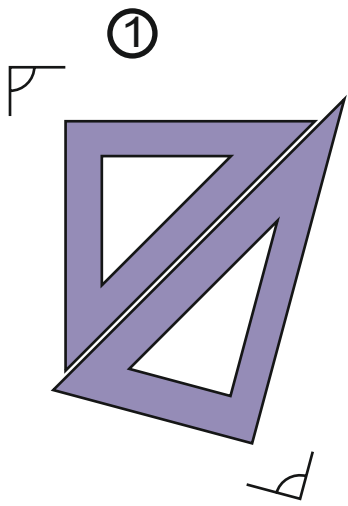

Zurdos

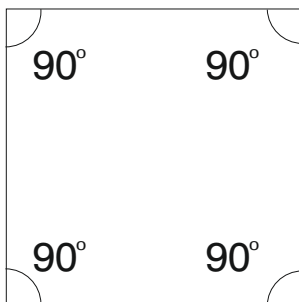
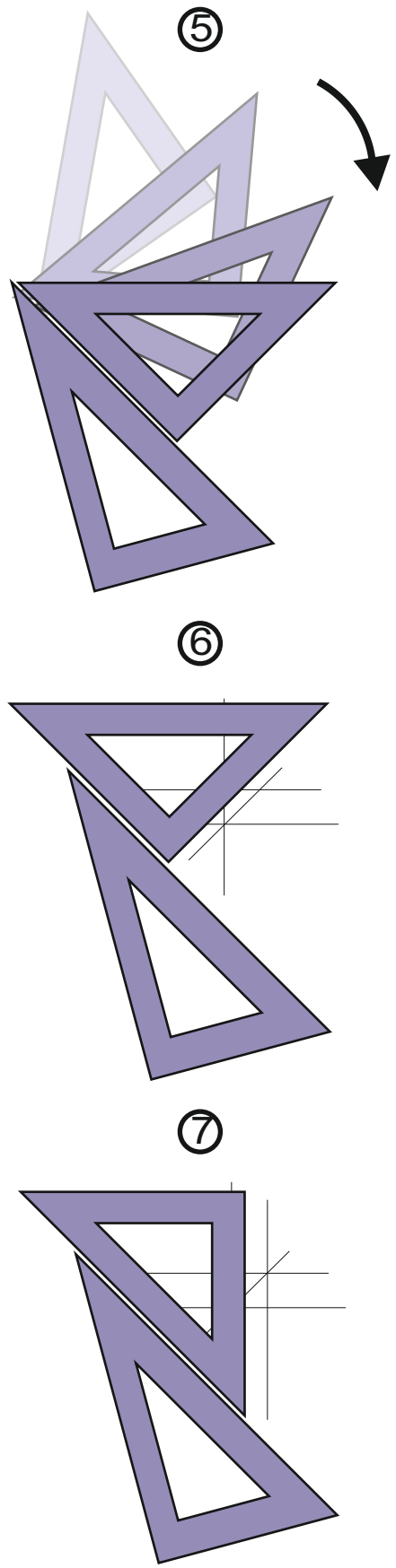
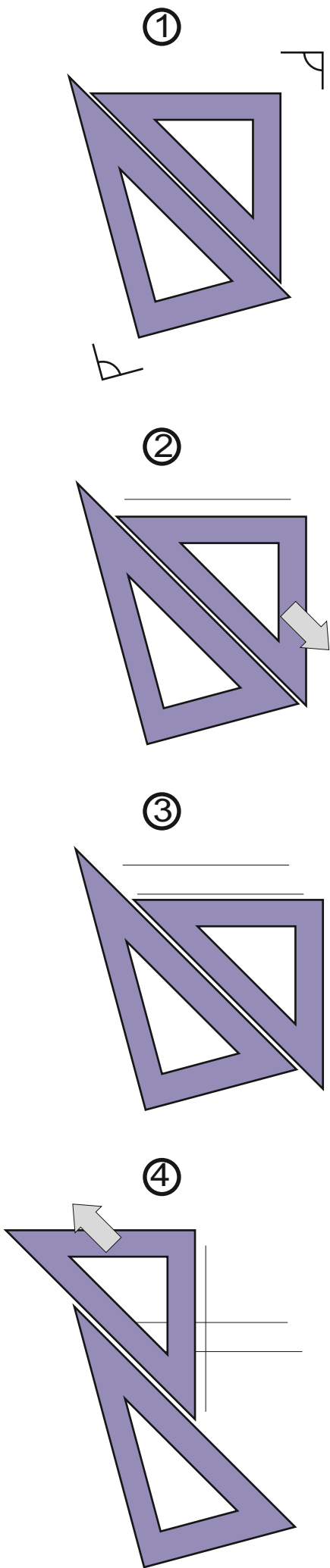

Diestros

①

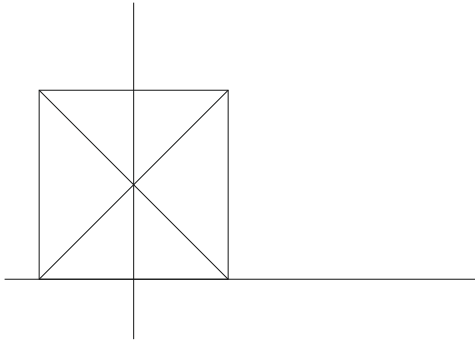

②

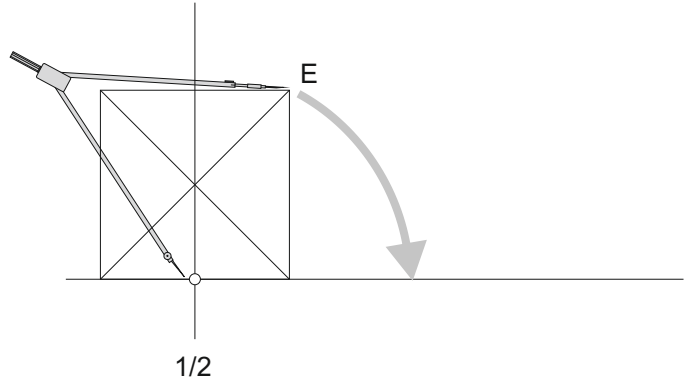

③

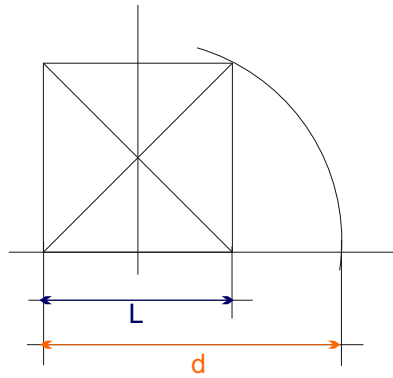

④

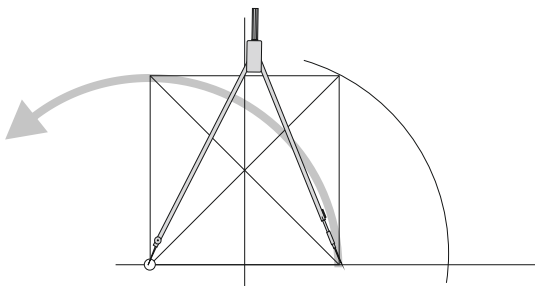

⑤

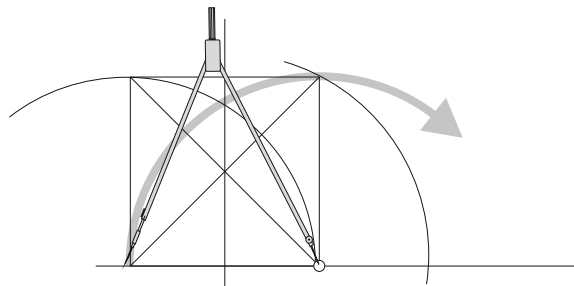

⑥

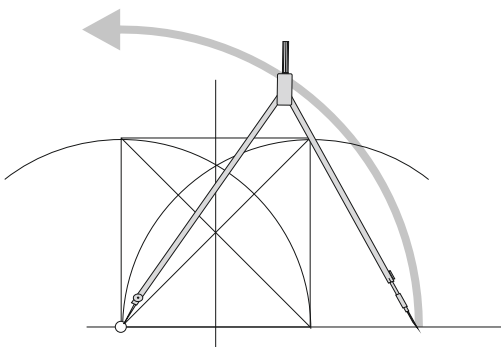

⑦

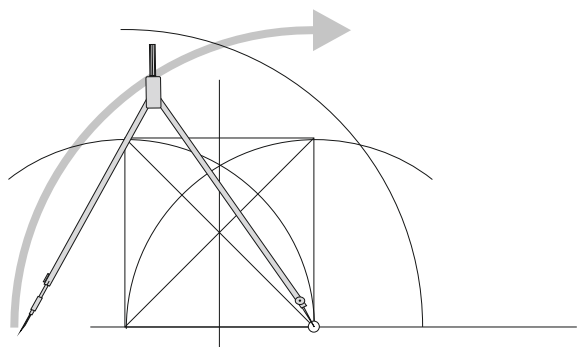

⑧

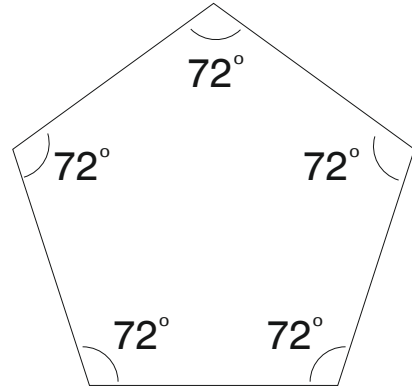
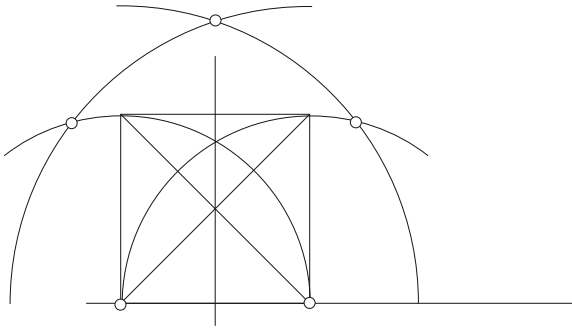

⑨

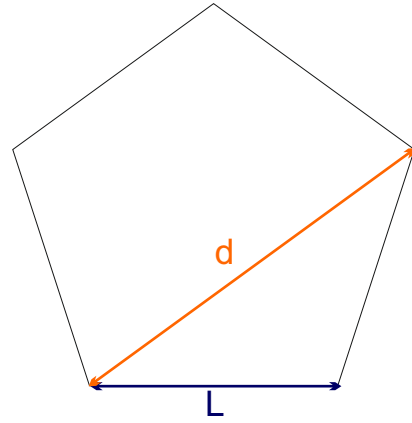
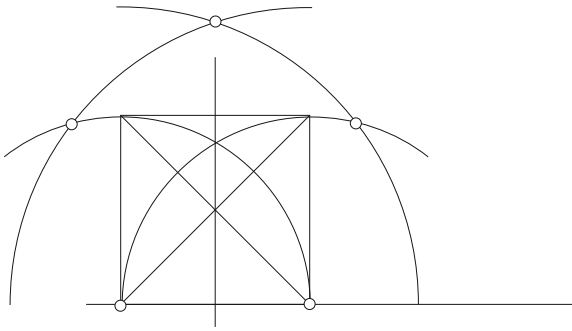

⑩

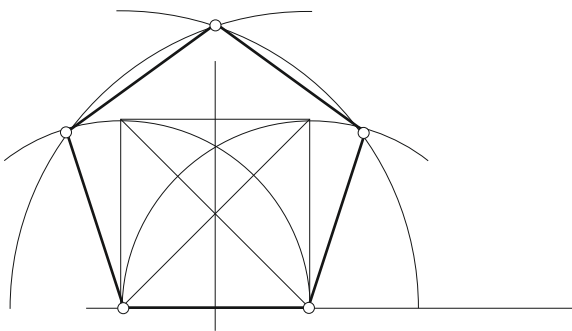

①

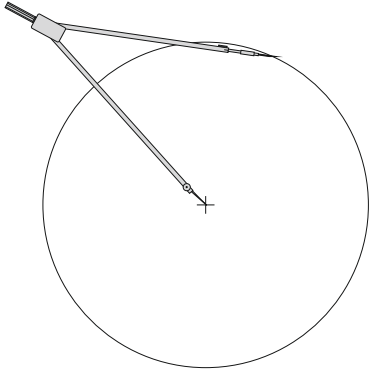

②

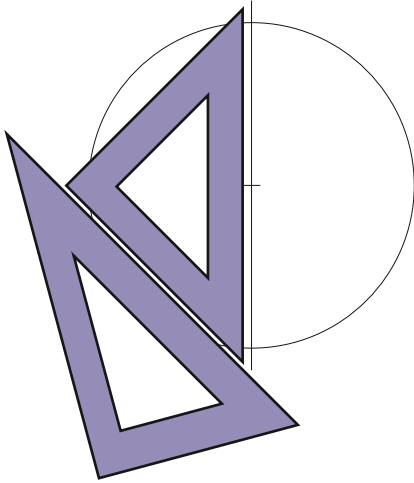

③

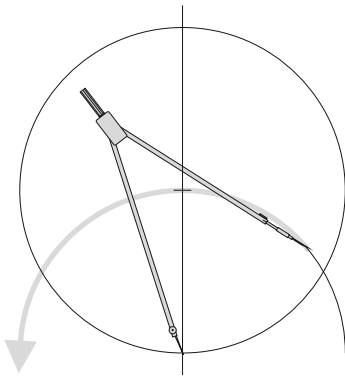

④

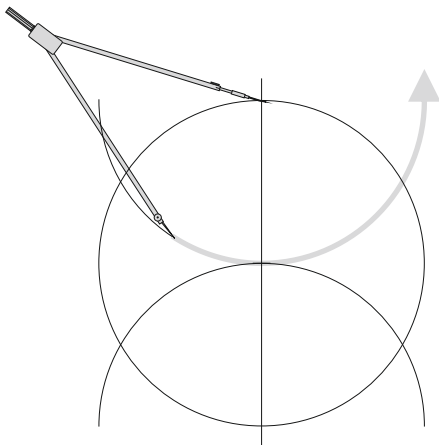

⑤

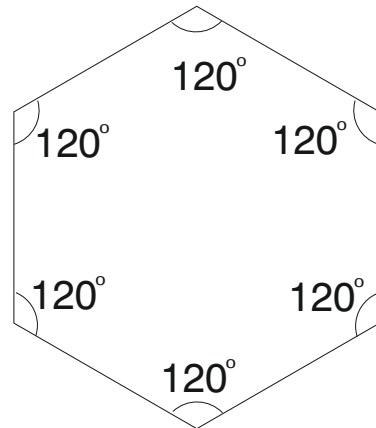
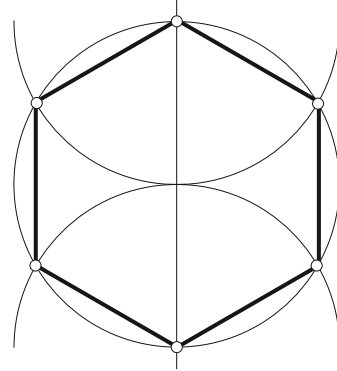

①

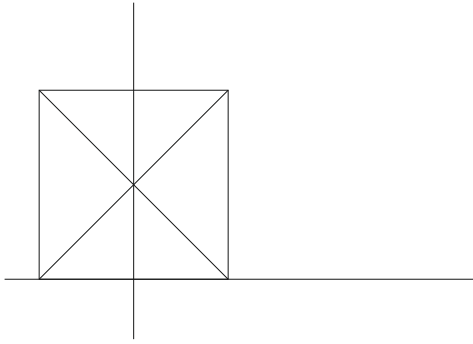

②

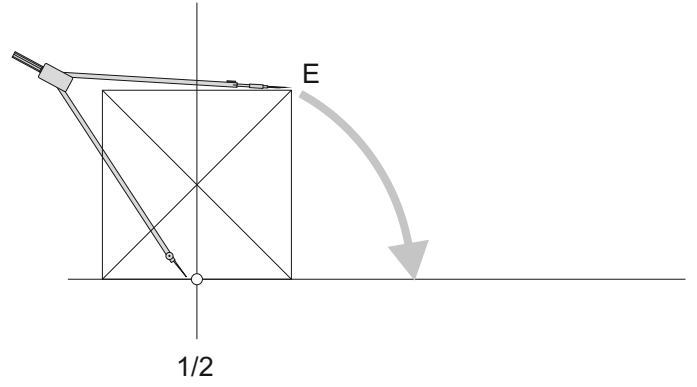

③

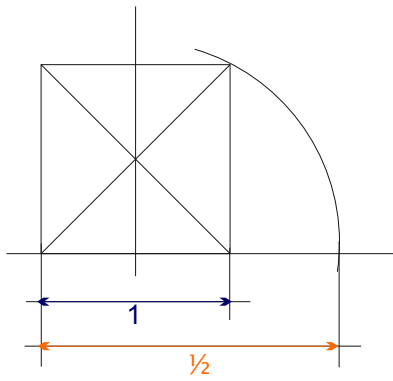

④

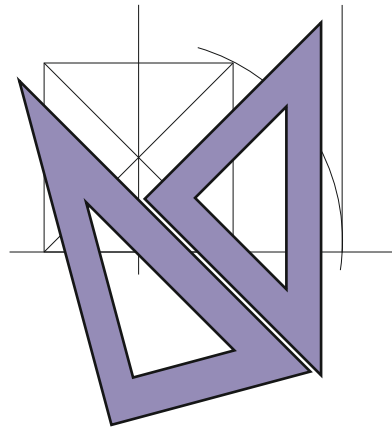

⑤

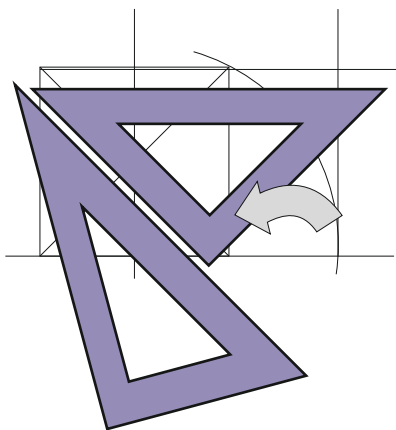

⑥

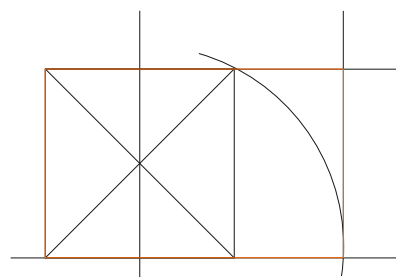

**rectángulo áureo**



7

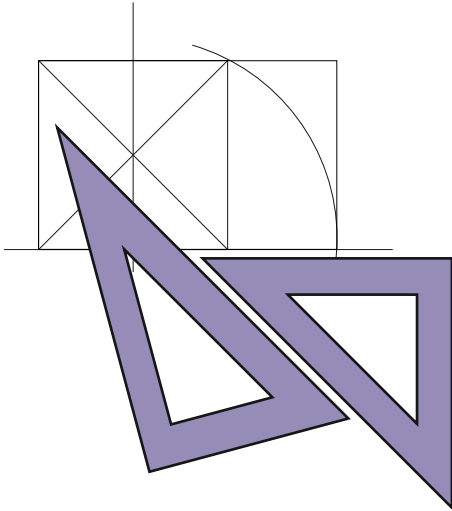

8

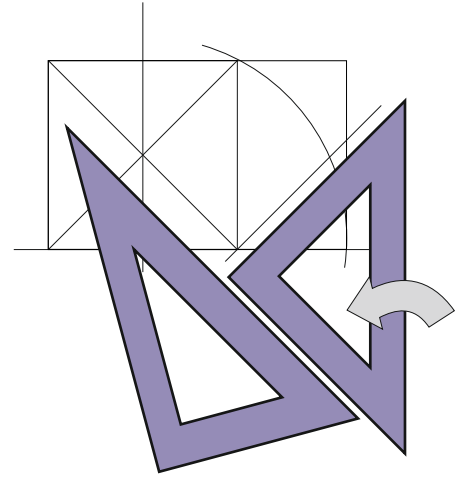

9

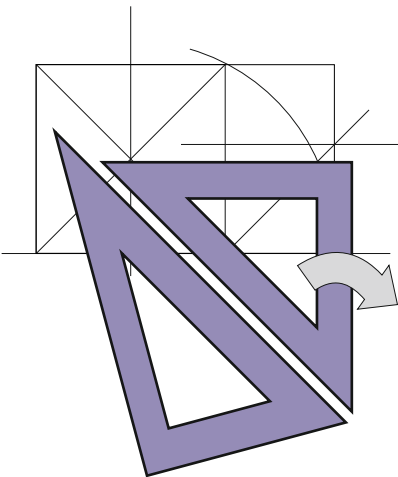

10

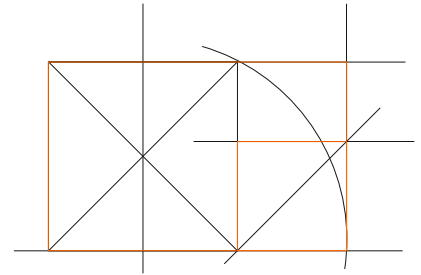

11

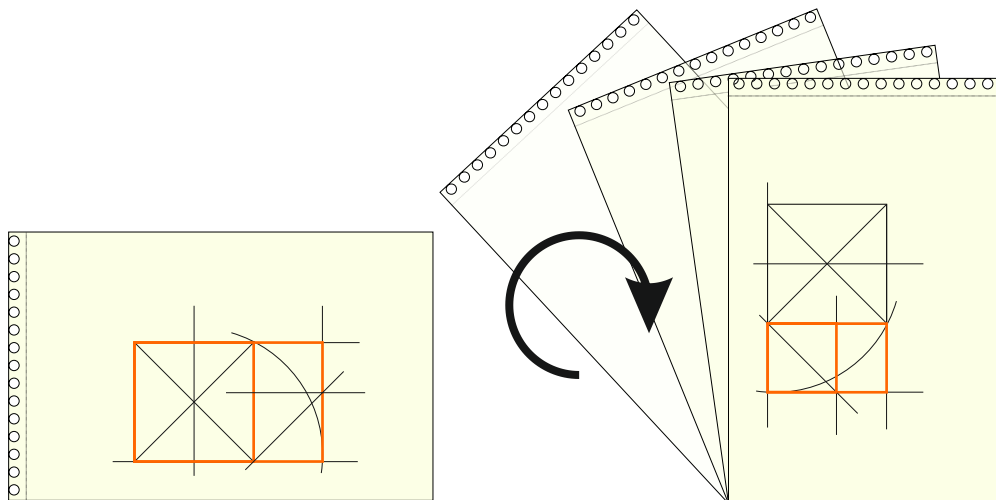

**repetir o procedimento tres veces mais  
xirando o papel no sentido das agulhas do relox**